

Caratteristiche principali

- Colonna di chiusura idraulica da 70 mm
- Raccordo superiore di entrata acqua in gomma
- Componenti interni smontabili per ispezione e pulizia periodica
- Corpo del sifone realizzato con due entrate e due uscite orizzontali e verticali, che consentono l'installazione sia da dx che da sx, indipendentemente dal posizionamento
- Uscita dello scarico da Ø18/20 mm per tubi corrugati ns. articoli 9899-050/052-01
- Il sifone funziona solo in senso verticale con il raccordo superiore di entrata acqua posizionato in alto
- Portata 100 l/h

Principales características:

- Columna de cierre hidráulica de 70 mm
- Empalme superior de entrada agua de goma
- Componentes internos desmontables para inspección y limpieza periódica
- Cuerpo del sifón con dos entradas y dos salidas horizontales y verticales que permiten la instalación tanto por la derecha como por la izquierda, independientemente de la colocación
- Salida del desagüe de Ø 18/20 mm
- para tubos corrugados artículos 9899-050/052-01
- El sifón funciona solo en sentido vertical con el empalme superior de entrada del agua colocado arriba
- Caudal 100 l/h

Main features

- 70 mm hydraulic closing column
- Top rubber water inlet
- Removable internal components for periodic inspections and cleanings
- Trap body equipped with two horizontal inputs and outlets, allowing for an installation both from the right or from the left, regardless of the position
- Ø18/20 mm drain output for corrugated pipes, our items 9899-050/052-01
- The trap only works vertically with the top rubber water inlet positioned on top
- 100 l/h capacity

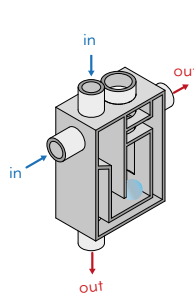

IN USO
EN FUNCIÓN
IN USE

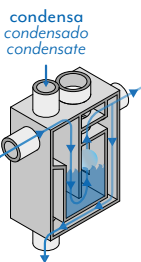

A RIPOSO
APAGADO
AT REST

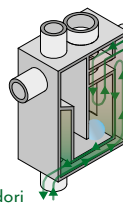

cattivi odori
malos olores
bad smells

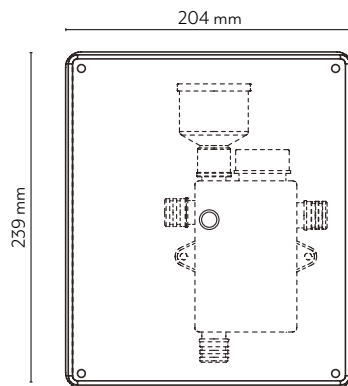
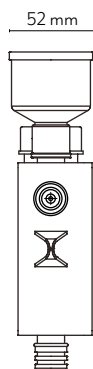
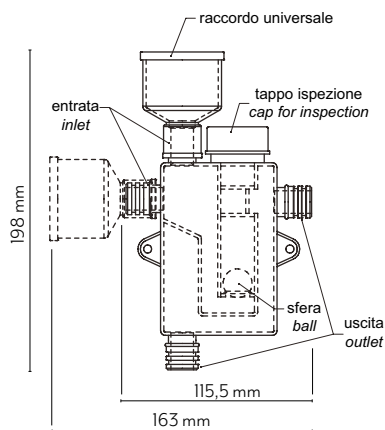

KIT SIFONE MECCANICO A SECCO ISPEZIONABILE "DOUBLE"

Kit sifón mecánico a seco inspeccionable "DOUBLE"

Dry mechanical inspectionable "DOUBLE" trap kit

- Sifone con tappo ispezionabile e sfera
- Guarnizione tecnica
- O-ring di tenuta
- Scatola con coperchio e viti
- Sifón con tapón inspeccionable y bola
- Junta técnica
- Junta tórica de estanqueidad
- Caja con tapa y tornillos
- Inspectionable trap with cap and ball
- Gasket
- Seal O-ring
- Box with cover and screws

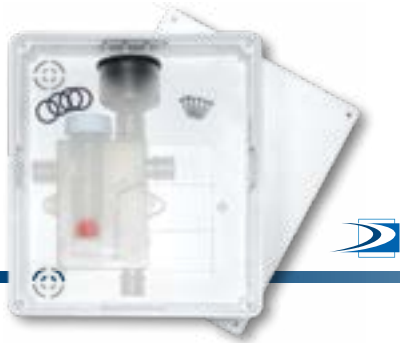

cod

9899-240-01

SIFONE MECCANICO A SECCO ISPEZIONABILE "DOUBLE"

Sifón mecánico a seco inspeccionable "DOUBLE"

Dry mechanical inspectionable "DOUBLE" trap

cod

9899-241-00

Esempio di installazione

Ejemplo de instalación

Installation example

